

Trials

Standing Regulations

TRIALS – MACHINE EXAMINER’S CHECK LIST	186
TRIALS OFFICIALS	187
ARENA TRIALS	188
ACU NORMANDALE MASTERS TRIALS CHAMPIONSHIP	190
ACU WESSEX PLANT HIRE BRITISH SIDECAR TRIALS CHAMPIONSHIP	192
ACU BELLE TRAILERS BRITISH LADIES AND GIRLS TRIALS CHAMPIONSHIPS	194
ACU S3 PARTS NATIONAL TRIALS CHAMPIONSHIP	196
ACU TRAIL BIKE SERIES INCORPORATING THE ACU TRAIL BIKE CHAMPIONSHIP	198
ACU BELLE TRAILERS BRITISH SOLO YOUTH TRIALS CHAMPIONSHIP	200

The National Sporting Code of the ACU and these Standing Regulations shall apply to all Trials together with the Supplementary Regulations and any Final Instructions issued for individual events.

DESCRIPTION

A Trial is a test of riding skill and balance over a variety of observed obstacles with riders incurring penalties for footing or for failing to fulfil other conditions.

AUTHORISATION AND LAND USE

The contents of "Procedures and safety arrangements for events using Forestry Agreement land" must be adhered to for any appropriate events.

Most events depend on goodwill from landowners, local authorities, nearby residents and other users of the countryside. For the continuance of orderly motorcycle sport, a Code, formulated by LARA has been adopted by the ACU. The Code for events with no speed element is reproduced below and will supplement the Standing Regulations. It is to be noted that where necessary disciplinary action will be taken if the Code is not fulfilled.

1. Any competitive event that is routed along, or across, footpaths or bridleways must be endorsed in advance by the Highways Authority for the area, unless the route of the event is on a highway of higher status.
2. The Organiser is responsible for obtaining authority from landowners over whose land the event passes, unless the route of the event is on a highway of higher status.
3. Where the event requires use of public highway, organisers must ensure that the Motor Vehicles (Competitions and Trials) Regulations 1969 are strictly adhered to. Events requiring authorisation must obtain this through the RAC Motor Sports Association, Authorisation Dept.
4. The Organiser is responsible for ensuring the event meets all requirements of the Road Traffic Act 1988 and the Statutory Instruments made thereunder.
5. The regulations, final instructions of an event should display the following sign: "This event is routed along and/or across public rights of way. Competitors must exercise caution and reduce their speed accordingly near other path users. Be especially careful near horses. Slow down, stop and switch off your engine if necessary."
6. The Organiser should appoint an officer responsible for event liaison. The Liaison Officer should, if appointed submit his name and address to the local Highway Authority, the Parish Council, the Police and landowners over whose land the event passes. The Liaison Officer will thoroughly investigate any complaints and try to resolve any problems arising from the event.
7. Wherever possible the Liaison Officer should maintain good relations with other path users in the area such as horse-riders, walkers, cyclists, recreational motoring groups and orienteers. The Liaison Officer should notify these groups in advance of an event where they are known to him.
8. All competitors must follow the Country Code.
9. Ensure that all aspects of the ACU Environmental Code are adhered to.

10. Emergency information

Supplementary regulations should include either a map reference or a postcode relating to the venue in order to assist the Emergency services.

NB In addition it is recommended that the map reference, farm name, address and postcode should be available at each Section together with the Mobile telephone number of the Secretary of the Meeting. The preferred method is to have this information on a card encased in a plastic wallet on a lanyard. Examples of these are available from ACU Offices.

Dogs At some venues Dogs may be prohibited. Where they are allowed, they are to be kept under control and owners are responsible for clearing up any fouling which may occur.

TSR1 ELIGIBILITY/LICENSING

All riders and passengers must hold a current ACU/SACU Trials Registration card or an ACU/SACU competition licence. Any rider or passenger from another FMN MUST produce a licence issued by their FMN together with start permission and proof of personal accident Insurance.

Where the Trial includes the use of public highways, then this will be stated in the Supplementary Regulations. If public highways are used then it is the sole responsibility of the rider to ensure that their machine is roadworthy and that they and their machine comply with all legal requirements.

RIDERS/MINDERS/ASSISTANTS AGE

- a) **Adult riders:** A rider must be at least 16 years of age to participate as an Adult.
- b) **Sidecar passengers:** In principle a Sidecar passenger must be an Adult however riders may be allowed to compete in Adult events subject to the discretion of the Trials and Enduro Committee and subject to them having a minimum age of 14 years. Nominated drivers/passengers must ride the entire event in their designated positions.
- c) **Youth Riders:** A rider must be at least 4 years of age to participate on an Electric powered machine and 6 years of age to participate in a trial using a combustion engine machine. After their 16th birthday a rider may compete as an Adult or as an A Class Youth until the end of the calendar year that they reach 17yrs and may alternate (on an event to event basis) between Youth and Adult classes subject to the following:
 - whilst riding as an A Class Youth the rider is restricted to machines of an A Class Youth
 - whilst riding as an Adult, capacity restrictions do not apply.
 Any rider who competes as an Adult in the Championship Class of the Adult British Solo Trials Championship relinquishes the possibility to revert to Youth in the future.
- d) **Minders/Assistants:** In events where Minder/Assistants are allowed, their minimum age must be 18 yrs.

YOUTH AGE GROUPS

- A Class born between 01.01.2003 and 31.12.2004
- B Class born between 01.01.2005 and 31.12.2008
- C Class born between 01.01.2008 and 31.12.2010
- D Class born between 01.01.2011 and 31.12.2014

Note: To ride a Combustion engined machine the rider must have attained 6 years.
 E Class Minimum age – 4 years and born after 01.01.2015.

Note: The rider must have attained 4 years at the date of the competition.

NB IMPORTANT INFO FOR B/C CLASS RIDERS IN 2020

Riders who reach the age of 12 in 2020 (ie born after 31.12 2007) will have the option of either:

- Moving to the B class in the year in which they reach 12 yrs on a machine up to 125cc (and being eligible for B Class points)

NB : The rider must be 12 years of age at the date of competition to ride a machine of 125cc Mono

OR

- Remaining in the C Class for another year on a machine of up to 80cc and retaining eligibility for C Class points.

ENGINE CAPACITY/WHEEL SIZE FOR ABOVE AGE GROUPS

The maximum permitted for machines used in the Age Groups set out in this Regulation are as follows:

A Class

125cc Mono or up to 250cc Twinshock** combustion engine, and Electric up to 10bhp measured at the rear wheel.

B Class

125cc Mono or up to 250cc Twinshock** combustion engine, and Electric up to 10bhp measured at the rear wheel.

** Twinshock machines over 125cc must have twin rear suspension units and drum brakes as at the time of manufacture.

C Class Standard Wheel

80cc combustion engine, and Electric up to 7bhp measured at the rear wheel

C Class Medium Wheel

80cc combustion engine

Electric up to 7bhp measured at the rear wheel

D Class with Medium Wheel

80cc combustion engine

Electric up to 7bhp measured at the rear wheel

D Class with Small Wheel

80cc Combustion Engine

Electric up to 7bhp measured at the rear wheel

E Class

Small wheel Electric powered machines up to 2bhp measured at the rear wheel.

Wheel sizes

Standard Wheel – 21" Front – 18" Rear

Medium Wheel – 19" Front – 17" Rear

Small Wheel – 16" Front – 14" Rear

A rider must enter the class which corresponds with the wheel size of his/her machine. The above is based on the wheels of combustion engine machines using motorcycle tyres. If other wheels are used as on current Electric powered machines then the outside diameter (total circumference) of the tyre must not exceed that of the corresponding tyre size.

Engine Sizes

Rebores are permitted subject to the resulting engine capacity not exceeding a tolerance of +3cc.

Criteria for riders wishing to ride in any higher class:

- Events below National status – a rider may compete in any class higher than that of his/her age group at the discretion of the organizers.
- National status competitions – a rider may at the discretion of the Trials and Enduro Committee be permitted to ride in the higher class. Applications to be made in writing.

Criteria for riders wishing to ride in any lower class:

- A rider may enter any event in a class below that of his/her age group on a "no award, no points" basis.

In all cases the rider must always comply with the maximum capacity and wheel size for their actual age.

TIME AND OBSERVATION RULES FOR YOUTH TRIALS (A & B CLASS RIDERS)

1. Qualified First Aid Personnel with equipment and transport must be in attendance.
2. The course must be marked in such a manner that excludes sharp corners and blind bends wherever possible.
3. Travelling Marshals will be provided to give at least one per two miles of course.
4. The Regulations must include the note "This Event is not recommended for Novice Riders".
5. The general public are to be discouraged from entering the area of the course.
6. Any other Youth class riders are only allowed to participate after prior approval of the Trials and Enduro Committee.
7. A Steward appointed either from ACU Headquarters or from the Local Centre should be in attendance.

TSR2 ENTRIES

An Event Entry Form must be completed in every detail, and signed by each rider and passenger. Each completed entry form, together with the entry fee (which includes riders/passengers insurance premiums for personal accident and off road risks) and Entry Subscription (see NSC 7.05) shall be forwarded to the Secretary of the Meeting. NB See also TSR 29 – Insurance.

All riders, passengers and appointed persons responsible for minors, must register arrival at an event by signing-on at the event control office, or other designated area, not less than 30 minutes prior to commencement of the competition.

Riders and Passengers under 18 years of age (Minors): In order to conform with the Children Act legislation, additionally, for every rider or passenger who is under 18 years of age a Parental Agreement must be signed. The Parental Agreement is incorporated in the Annual Competition Licence and Trials Registration form and once completed will serve as the riders Annual Parental Agreement. All minors will be bound by the directions of parent(s), guardian(s) or other appointed adult responsible for them at any event. The following guidelines apply:

Minors Under 14 The Parental Agreement must be signed by a parent or legal guardian who must also be present when the rider competes.

Minors Aged 14 or 15 The Parental Agreement must be signed by a parent or legal guardian who must also be present when the rider competes unless they have specified another responsible adult who may sign for and accompany the rider at events.

Minors Aged 16 or 17 The Parental Agreement must be signed by a parent or legal guardian. There is no requirement for the minor to be accompanied to events by an adult.

Child Protection: The point of contact for Child Protection issues will be the Secretary of the Meeting unless otherwise stated in the Supplementary Regulations.

TSR3 LIMITATION OF ENTRIES

Any limitation on the maximum or minimum number of entries to be accepted, together with the method of limitation (e.g. in order of receipt, by ballot, etc.) must be included in the Supplementary Regulations.

TSR4 WARNING NOTICES

Organisers should display Warning Notices at the event, recommended to be placed at any point of the course where the public is likely to congregate.

TSR5 TEAM NOMINATIONS

TEAM-ONLY COMPETITIONS (E.G. INTER CENTRE).

All riders and passengers must sign an entry form and all entries must be made via an appointed Team Manager.

TRIALS INCORPORATING COMPETITION FOR TEAMS.

Teams shall consist of riders who have entered individually and such riders must complete a declaration on the entry form signifying their consent to nomination as a team member.

TYPE OF TEAM

- a) **Club Teams.** A rider must be a registered member of the nominating Club and may be nominated as a member of one Club Team only.
- b) **One Make of Manufacturers' Teams.** Teams shall consist of riders all riding machines of the same manufacturer.

Details of further teams if any shall be contained in the Supplementary Regulations.

TSR6 CHANGE OF RIDER

All entries will be deemed to be in respect of the rider so named and no change of rider will be permitted except in the case of "Team Only" competitions where the Team Entry is submitted by a

Team Manager. For “Team Only” competitions any change of an individual entry will be subject to the conditions of the Supplementary Regulations.

TSR7 CHANGE OF MACHINE AND/OR PASSENGER

Any request for change of machine and/or passenger must be made in writing and submitted to the Secretary of the Meeting at least one hour prior to the start of the event. The same machine must be used throughout the event. In the case of a sidecar this is deemed to be an integral part of the machine.

TSR8 MOTORCYCLES

Motorcycles must comply with Appendix D of the National Sporting Code. Prior to the start of each Event all machines shall be examined to ensure that they comply with ACU specifications. When the event uses the public highway it is the sole responsibility of the rider to present a machine complying with all Road Traffic Act(s) requirements Organisers may at their discretion, allow riders to share the same machine in a Closed to Club Trial held on private land.

SOLO: Motorcycles propelled by the action of one wheel in contact with the ground and making only one track on the ground. Machines must have independent brakes on both front and rear wheels.

Brake and Clutch levers. All handlebar levers (clutch, brake etc.) must be in principle ball ended. These ends must be permanently fixed and form an integral part of the lever.

Mudguards must be fit for purpose and corresponding to the original equipment.

Footrests must be of the folding type.

Throttle must be self closing when not held by the hand. The machine may be set with a “tickover”.

Wheels If of cast, or fabricated construction (other than conventional spoked wheels) then protection must be provided to the rear wheel by the fitting of ‘solid discs’ to cover open areas.

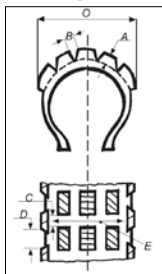

Tyres. Only tyres which conform to the following specification may be used. All tyres will be measured mounted on the rim inflated to a pressure of 14lb/sq.in, and must have a nominal aspect ratio of 100/100. Overall width (O) measured at wheel spindle height must not exceed 115mm. (Refer to diagram). Tread depth (A) must not exceed 13mm. All tread blocks in the same circumference must be of the same depth. The space between the tread blocks (B) must not exceed 9.5mm across the tyre or 13mm in a circumferential direction (C). The space between the shoulder blocks (D) must not exceed 22mm. The space across the tread (E) must not extend completely across the tyre measured at right angles to the tyre wall unless broken by a block. All main tread blocks must in principle be parallel with or at right angles to the tyre axis. (Tyre must have the same appearance if reversed and conform in principle with these diagrams). The tyre

surface must not be fitted with any subsequently mounted elements such as anti-skid devices, chains, etc. NB: Only tyres available from commercial sources and complying with these dimensions are permitted in competitions. Where the event uses the public highway, tyres must be manufactured to comply with European Tyre & Rim Technical Organisation and have the relevant markings.

Tyres for Long distance Trials Tyres Spec as per TSR8 for ACU Trail Bike Championship events.

Tyres used in non-championship events must be road legal and the tread pattern is to be at discretion of the organisers and as stated in the Supplementary Regulations.

Cutout Device. With the exception of Four Stroke Sidecar machines fitted with external magnetos ignitions, all machines used in Youth and Sidecar competitions must be fitted with an operational lanyard cut out device so as to stop the engine/motor should the rider and machine be parted. The lanyard from the cut out device must be securely fitted to the rider and be of a length not greater than 1m when fully extended.

It is recommended that all machines used by Adult riders be fitted with a lanyard operated cut out device as described above.

Chainguards must be fitted to all motorcycles as per manufacturer’s specification.

Engine Measurement Where it becomes necessary for the ACU or an organiser to verify any fact relating to an engine size, it shall be carried out at the cost of the rider. Where an engine is measured, as the result of a protest, the protest must be submitted with the appropriate fee plus a deposit of £250.00 which can only be returned if the protest is upheld. If the protest is unsuccessful then the deposit will be awarded to the person against whom the protest has been made and the protest fee will be sent to the ACU Benevolent Fund. The Clerk of the Course shall judge as guilty anyone who refuses to present an engine for measurement. A rider whose machine is found to have an engine size not complying with the rules will be disqualified and will be liable to further disciplinary action. If engines are presented for measurement, but this cannot be carried out at the event, the engines must be sealed for later measurement. If seals are damaged or removed the rider will be disqualified and subject to a fine.

TRIALS SIDECAR SPECIFICATION

All motorcycles in Categories B (1), B (2) and B (3) shall comply with the following requirements:

- a) The entire body, including the floor, shall be either sheet metal or other substantial material, and the Sidecar must be rigidly fixed to the motorcycle.
- b) Minimum dimensions shall be:
 - A. Measurement from the nose to dashboard – 375mm (15")
 - B. Overall length nose to tail – 1350mm (54")
 - C. The height of the body at the apex of the dashboard position – 375mm (15")
 - D. The overall distance between the outside of the Sidecar mudguard or bodywork and the inside of the passenger’s seat measured at right angles to the machine track – 300mm (12")
 - E. Width of body at forward end – 150mm (6")
 - Depth of body at forward end – 150mm (6")
 - OR if the forward end is hemispherical and radius shall be not less than 75mm (3")
- F. Track – minimum 876mm (34½")

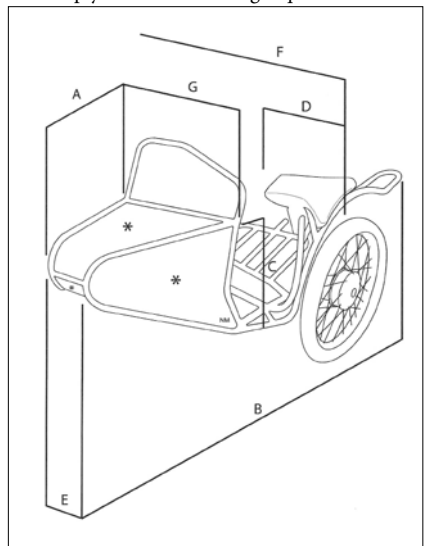

- The distance is measured from the centre of the track left by the rear wheel to the centre of the track left by the sidecar wheel.
- G. Overall width of cockpit at seating position – 300mm (12")
- A seat measuring not less than 180mm (7.5") × 125mm (5") must be fitted. The height of the seat shall be not less than 300mm (12") from the floor of the sidecar.
- c) The fitting of grab rails, handles, straps etc shall be according to the driver’s requirements.
- d) Protection for the passenger must be provided from the rear wheel, the primary and final drive of the motorcycle, and from the sidecar wheel, by means of either a mudguard or the coachwork of the sidecar.
- e) The use of sidecar wheel drive is prohibited.

TSR 9 FUEL

Commercially available unleaded fuel must be used. Power boosters or octane boosters are forbidden. Refuelling must not take place when the engine is still running. Mobile Phones must not be used in refuelling areas.

ENVIRONMENTAL MATS

All machines and generators must stand on an Environmental mat whilst being refuelled.

TSR10 TELEMETRY

The use of Telemetry between the rider/motorcycle and any other person/equipment by radio means is not allowed.

TSR11 RIDING NUMBERS

Riding numbers issued by the organisers, whether card or numbered bibs must be clearly displayed in a legible condition throughout the competition. Riding numbers shall not be defaced in any way and no event sponsors advertising shall be covered. Riding numbers shall be removed at the Finish. Where there are different section routes for different classes of rider, each rider shall be issued with a means of identification to reflect the route the competitor is riding.

TSR12 CLOTHING

Clothing must cover legs and body and it is recommended that arms should be covered. Boots of approximately knee length made of leather, rubber or plastic must be worn. The wearing of gloves is recommended.

Motorcycle helmets Competitors, both riders and Sidecar passengers must wear a correctly fitted helmet at all times during the event whilst riding a motorcycle or quad. Officials must wear a correctly fitted helmet whilst riding a motorcycle at all times during the event, and it is recommended that they wear a helmet whilst riding a quad. Unless the helmet is manufactured with the camera as an intrinsic part, helmet cameras (including the helmet camera brackets) and cameras attached to the body are prohibited. Cameras attached to the machine are permitted.

Jewellery Competitors are advised not to wear hand, face or body jewellery which could prove hazardous in the event of an accident. The mouth should be kept clear of anything likely to cause a blockage of the airway in the event of an accident, e.g. chewing gum.

Youth All Youth competitors must have clothing covering arms and wear gloves covering hands and fingers.

TSR13 PILLION PASSENGERS

The carrying of pillion passengers is not allowed except where provision has been made for this in the Supplementary Regulations.

TSR14 CONTROL OF EXHAUST SOUND LEVEL

The sound level of a Trials machine controlled according to the ACU method and measured at 2 metres distance will not exceed 100 dBA (For precise method of testing, see Sound Control Regulations in this Handbook).

There may be one or more random sound level tests during the event for which the rider will not be allowed to make any adjustments. A rider whose machine exceeds the maximum permitted sound level or does not present his machine in a testable condition will face immediate disqualification and must return to the finish as directed. Additionally, at any time during the event, the Clerk of the Course or the appointed official is empowered to disqualify any machine he considers excessively noisy.

TSR15 START AND FINISH

Prior to Starting, the rider must have signed on, had his/her machine examined and be suitably dressed. All riders, including riders who have retired, must report to the Finish where they may be required to sign off. The method of deciding the starting order will be stated in the Supplementary Regulations or, where applicable, in the appropriate Championship Regulations.

TSR16 TIME

For Trials other than Time and Observation Trials, where full details regarding the calculation of time penalties shall be included in the Supplementary Regulations, the following shall apply; if a time restraint is applied to part or all of the Trial, it shall be in the form of an individual allowance for each rider and the details given in the Supplementary Regulations or Final Instructions. Wherever a Time restraint is applied there must be a Clock showing the Official time visible to all riders at each time control point.

A rider's Time Allowance shall commence from the actual time the rider starts. The location of the final Time Control should be at the last section, or as close as practical. Riders will be penalised one mark per minute or part of that minute up to a maximum of twenty for late starting, and for arriving late at any subsequent Time Control, and thereafter disqualified.

It is recommended that the time limit shall not be extended other than in the case of Force Majeure as determined by the Clerk of the Course.

TSR17 COURSE/ROUTE

The Clerk of the Course must ensure that due consideration is given to the age and abilities of the riders when planning and marking the course and that suitable marking is displayed to guide and restrict any spectators/members of the Public who may attend.

The onus of following the correct route rests entirely with the rider. A rider leaving the course must rejoin it at the same point. When public roads are used to connect areas of private land a map clearly showing their position must be displayed at the Start or in the programme. The onus of finding these areas of private land rests entirely upon the rider and any route marking provided by the organisers is purely for assistance. The Clerk of the Course reserves the right to modify the route. To qualify as a finisher and be eligible for an award, with the exception of a section where the rider has recorded a failure, the rider's machine must have travelled the whole distance under its own power or the exertion of the rider and passenger. Any rider, who on any private land is accompanied by another vehicle unconnected with the event, is liable to disqualification. Any competitor who is, in the opinion of the Clerk of the Course, considered to be riding the course for the benefit of another competitor is liable to disqualification and reporting to the Stewards for further disciplinary action.

If route marking is appropriate it is recommended that discs (square, round, etc – not arrows) are used to signify the direction – red for right, blue for left and white to straight on. It is suggested also that where a red or blue disc is used then following the turn, there should be a white to assure the rider that the correct route has been taken.

TSR18 OBSERVED SECTIONS

The organiser must display which route each class is riding indicating the corresponding colours of the route marking. Details may be displayed at signing on, at the first section or contained in the Final Instructions or programme. Riders in the same class must all start at the same section.

It is recommended that routes be marked as follows:

Route 1 – Principal Route – Blue (left) Red (right)

Route 2 – Yellow both sides

Route 3 – White both sides

Any further routes to be marked in a colour chosen by the Organiser.

In the above, the letters denote the severity of the sections in descending order ie Route 1 would be hardest, Route 2 next hardest and so on.

Routes may be marked in their entirety in the colours shown – or the Organiser may mark appropriate diversions in these colours. Ideally – the coloured section of markers should be in the shape of an arrow – with the point toward the centre of the section.

No penalty shall be imposed on a rider who wishes to inspect a section before riding it.

The lateral limits of an Observed Section or Sub Section may be defined by artificial boundaries such as markers or tapes, which shall be firmly placed and positioned in a way so as to clearly define the

intended limits of the section. If tapes are to be used they shall always be clear of the ground but not exceed a height of 500mm from the ground.

The Start and Finish of each Observed Section or Sub-Section will be clearly defined, with the Section Begins and Section Ends identified as such.

Sections and Sub-Sections shall be numbered or lettered and ridden in the correct sequence unless otherwise instructed by the organisers.

A rider failing in a Sub-Section must restart in a forward direction from the Sub-Section in which he has failed.

To qualify as a Finisher and be eligible for an award, the competitor must be deemed to have made a bona fide attempt at least 75% of the sections.

TSR19 PUNCHCARDS

If punchcards are used, the onus of looking after these rests entirely on the rider and only the rider/passenger may present the punchcard to the observer. Any disagreement over the score punched, or errors must be reported to the Secretary of the Meeting immediately upon completion of the event. The Observer must be informed that this action is being taken as any error not verified by the Observer shall not be accepted. Refusing to have the card punched, deliberately disfiguring or losing the punch card will result in disqualification for which no protest will be accepted. Any rider who does not return his punchcard to the appointed Official without delay will be classed as retired.

TSR20 OBSERVERS

An Observer is an assistant to the Clerk of the Course appointed to judge a competitor's performance in an Observed Section. No protest or appeal can be accepted against a judgement of performance made by an Observer, however, a protest may be accepted against any breach, or misinterpretation of the Regulations.

A mistake made by an Observer may be corrected by the Observer with the approval of the Clerk of the Course.

TSR21 INSTRUCTION TO RIDERS

Any instruction to riders not included in the Supplementary Regulations (Final Instructions) must be approved by the permit issuing authority if issued prior to the event, or approved by the Stewards of the meeting if issued at the event.

Subject to being issued in one of the following ways they shall have the same force as these Standing Regulations.

- Issued in writing and distributed to each rider.
- Issued via a clearly situated notice board.
- Via a riders briefing meeting, providing all riders have been informed formally of the venue and time of such a meeting.

TSR22 METHOD OF MARKING

A machine will be deemed to be in an Observed Section or Sub-Section when the front wheel spindle has passed the 'Section Begins' Card and until the front wheel spindle has passed the 'Section Ends' Card. Marks will be lost as follows:

A. STOP PERMITTED

- | | |
|---|---|
| 0 | Clean |
| 1 | Footing once |
| 2 | Footing twice |
| 3 | Footing more than twice |
| 5 | Failure |
| 5 | When requested by a rider rather than attempt the section |
| 5 | Entering a section before being called upon to do so by an official |

10 Not attempting a section when called upon to do so by an official

10 For missing a section or failing to have punch card marked.

Graded Hills. Where a Section is to be termed a 'Graded Hill' a notice to that effect must be displayed at the Section Begins, and the following shall apply: Numbered boards must be placed at defined places along the Section, in order that a rider's performance may be determined. Marks will be lost in a decreasing manner from 5 to 0 depending on the distance a rider can traverse the Section without failure. The front wheel spindle is the part of the machine to be used in assessing the distance traversed.

Footing is allowed without penalty.

0 Clean

1 Reaching or passing the "1 Board" without Failure

2 Reaching or passing the "2 Board" without Failure

3 Reaching or passing the "3 Board" without Failure

5 Failure to reach the "3 Board"

5 When requested by a rider rather than attempt the section

10 Not attempting a Section when called upon to do so by an official

10 For missing a section or failing to have punch card marked.

DEFINITIONS

Clean: A rider traversing a Section as defined above without penalty as described under FOOTING or FAILURE shall be unpenalised and given a "CLEAN".

Footing: Footing will be considered to have occurred if any part of the rider's body or any part of the machine, (with the exception of the tyres or the sump shield) touches the ground or the rider benefit from any part of their body, or any part of the machine, (with the exception of the tyres or the sump shield) leaning on an obstacle (tree, wall etc.)

Footing outside the lateral limits of a Section does not constitute a failure but should simply be classed as footing.

Failure: A failure is considered to have occurred if:

- a) The machine moves backwards.
- b) The rider does not have both hands on the handlebar WHEN HE FOOTS WHILST STATIONARY.
- c) The engine stops WHILST ANY PART OF THE MACHINE, WITH THE EXCEPTION OF THE TYRES, TOUCHES THE GROUND OR THE RIDER IS FOOTING.
- d) The rider dismounts from the machine. Dismount will be deemed to have occurred when both of the rider's feet are on the ground at the same side of, or behind the machine.
- e) A machine does not stay within the intended limits of the section as defined by the Observer.
- f) If any wheel of the machine crosses any boundary tape or goes over or on the wrong side of a marker, whether the wheel be on the ground or airborne, before the front wheel spindle passes the "Section ends" sign.
- g) The rider is held responsible for displacing a marker or support in an observed section whereby the observer considers it necessary to reinstate the flag/marker prior to the passage of the next rider.
The displacing of any marking not relating to the competitor's route will be considered to constitute a failure.
- h) Travelling in a forward direction against the direction of the Section.
- i) The motorcycle crosses its own track with either wheel.
- j) The machine or rider receives outside assistance.
- k) A rider or person having an interest in a rider's performance, who in any way alters the severity of a section without the authority of an official.

Note: A rider not exiting the section after recording a failure when requested to do so by the Observer will be awarded an additional penalty for causing unnecessary delay.

For all trials other than those for which Championship Regulations apply the organiser may, with the agreement of the Permit Issuing Authority, apply a time limit to each section. The time allowed must be the same for each and every Section and the penalty for a rider not completing the Section within that time would be failure. If a time limit is to be applied to the Sections then this must be clearly stated in the Supplementary Regulations.

B. NON-STOP (SOLO & SIDECAR)

- 0 Clean
- 1 Footing once
- 2 Footing twice
- 3 Footing more than twice
- 5 Failure
- 5 When requested by a rider rather than attempt the section
- 5 Entering a section before being called upon to do so by an official
- 10 Not attempting a section when called upon to do so by an official
- 10 For missing a section or failing to have punch card marked.

Graded Hills. Where a Section is to be termed a 'Graded Hill' a notice to that effect must be displayed at the Section Begins, and the following shall apply: Numbered boards must be placed at defined places along the Section, in order that a rider's performance may be determined. Marks will be lost in a decreasing manner from 5 to 0 depending on the distance a rider can traverse the Section without failure. The front wheel spindle is the part of the machine to be used in assessing the distance traversed.

Footing is allowed without penalty.

- 0 Clean
- 1 Reaching or passing the "1 Board" without Failure.
- 2 Reaching or passing the "2 Board" without Failure.
- 3 Reaching or passing the "3 Board" without Failure.
- 5 Failure to reach the "3 Board".
- 5 When requested by a rider rather than attempt the section
- 10 Not attempting a Section when called upon to do so by an Official
- 10 For missing a section or failing to have punch card marked.

DEFINITIONS

Clean: A rider traversing a Section as defined above without penalty as described under FOOTING or FAILURE shall be unpenalised and given a "CLEAN".

Footing: Footing will be considered to have occurred if any part of the rider's body or any part of the machine, (with the exception of the tyres or the sump shield) touches the ground or the rider benefit from any part of their body, or any part of the machine, (with the exception of the tyres or the sump shield) leaning on an obstacle (tree, wall etc.).

Footing outside the lateral limits of a Section does not constitute a failure but should simply be classed as footing.

Failure: A failure is considered to have occurred if:

- i) The machine ceases to move in a forward direction.
- ii) The rider dismounts from the machine. Dismount will be deemed to have occurred when both of the rider's feet are on the ground at the same side of or behind the machine.
- iii) A machine does not stay within the intended limits of the section as defined by the Observer.
- iv) If any wheel of the machine crosses any boundary tape or goes over or the wrong side of a marker, whether the wheel be on the ground or airborne, before the front wheel spindle passes the "Section ends" sign.
- v) The rider or passenger is held responsible for displacing any marker or support in an observed section whereby the observer considers it necessary to reinstate the flag/marker

prior to the passage of the next rider.

The displacement of any marking not relating to the competitor's route will also be considered to warrant a failure.

- vi) The machine or rider travels in a forward direction against the direction of the Section.
- vii) The motorcycle crosses its own track with either wheel.
- viii) The machine, or rider or passenger receives outside assistance.
- ix) A rider or person having an interest in a rider's performance, in any way alters the severity of a section without the authority of an official.

For Sidecar events only.

A failure is considered to have occurred if:

The passenger foots i.e. if any part of the passenger's body touches the ground, or benefit is gained from any part of his body leaning on an obstacle (tree, wall etc.).

Note ACU Trial GB method of marking: see Championship Regulations for description. Only to be used in ACU Trial GB events

TSR23 TIES

A) Ties in an Event

Ties will be resolved by the following method in the sequence shown:

- a) In favour of the rider with the highest number of cleans.
- b) In favour of the rider with the highest number of one mark.
- c) In favour of the rider with the highest number of two marks.
- d) In favour of the rider with the highest number of three marks.
- e) In favour of the rider who travelled furthest with the least marks lost.
- f) In favour of the rider who completes the course with the least marks lost on time.

If not resolved by the above **and the organiser has stated so in the Supplementary Regulations** then a special test may be used for final deciding of ties.

If the event is part of a Championship and if a tie cannot be resolved in accordance with the above those involved in the tie will be allocated the Championship points of the highest place for which the tie exists.

B) Ties at the end of a Championship Series.

Should a tie occur in a Championship series it shall be decided as follows:

- a) In favour of the rider with the greatest number of wins in ALL rounds held.
- b) If not resolved then the greatest number of second places and so on down to 15th place in ALL rounds held.
- c) If not then resolved, by the rider with the best performance in the final event held. If neither rider competed in the Final round, the highest position will be awarded to the rider of the last round in which either competed.

TSR24 FINAL ASSESSMENT OF CHAMPIONSHIPS

The Championship Regulations for any Championship must state the number of rounds to count for the Final Assessment eg: "All rounds to count" or "All rounds held less one, or all rounds less two to count". If no indication is stated then it will be assumed that all rounds held will count.

TSR25 BAULK

A baulk is deemed to have occurred when a rider, whilst attempting an observed section, is prevented from making a bona-fide attempt due to some outside obstruction. Should a rider claim a baulk, the Observer may, at his discretion, allow a re-run of the section. The Observer's decision as to whether a re-run is permitted is final. Should a re-run be granted, any marks lost prior to the point of the baulk on the original attempt shall stand, and the section shall be observed from the point of the baulk.

Regarding any time allowed for the section the re-run shall start from the Section Begins and the time will be measured for the total section as if no obstruction had taken place.

TSR26 PRACTISING

Unofficial practising at the venue is prohibited. A breach of this regulation renders the rider liable to disqualification from the event and to be reported to the stewards of the meeting for disciplinary action. If official practice is to be allowed, either in a suitable area away from the paddock, or on the sections to be used, then full details must be stated in the Supplementary Regulations or relevant Championship Regulations.

Where another event takes place at the same venue it will not be considered to constitute unofficial practice.

TSR27 PREJUDICIAL ACTION

Any person having an interest in a rider's performance, who takes any action prejudicial to the sport may be liable to a penalty up to and including disqualification. Riders, parents or associates failing to obey instructions given by officials of a meeting or deemed to have unjustifiably or maliciously jeopardised the efficient running of the meeting by not adhering to the Regulations, Supplementary Regulations or the Protest or appeal procedure, may render the rider liable to a penalty up to and including disqualification and being reported to the permit issuing authority for further action.

TSR28 LEGAL ACTION

A rider who is convicted following a police prosecution for an offence committed by them whilst taking part in the competition may be liable to disqualification.

TSR29 INSURANCE

The responsibility is on the rider to ensure that his motorcycle complies with all legal requirements. The organisers will be required to cover riders and passengers against Personal Accident risk and for Third Party Insurance for 'off-the-road' risks whilst taking part in the event and the premium for such insurance will be included in the entry fee. The ACU have arranged third party RTA Insurance as a blanket cover across the whole Membership to cover any competitor, marshal or Official signed on for an ACU permitted event which, for the duration of the permit, will allow them to use any motor vehicle in connection with the event in areas of the event where the Road Traffic Act is deemed to be applicable. The RTA cover will be provided in the same way as the ACU Public Liability and other insurance covers. That is to say when the Rider, Marshal or Official signs on at an event, the cover is automatically in place. The RTA cover comes at no extra cost to the Organiser as this cover is provided free of charge by the ACU.

TSR30 ABANDONMENT

The organisers reserve the right, subject to the approval of the Stewards of the Meeting, to cancel, postpone or abandon the competition, if circumstances should arise which in their opinion, render such action necessary.

TSR31 MEDICAL SERVICES

It is recommended that a person holding a certificate of First Aid competency be present at all events. In addition it is recommended that the organiser shall be conversant with the nearest Accident/Emergency Services and ensure they have a means of contacting them. Where ambulances are in place, by law, they must be registered with the DVLA and be CQC-registered in order to transport a casualty to hospital. An ambulance must have an appropriately qualified driver to transport a casualty under blue lights. Organisers must also refer to the "Medical Services and Definition" section of this Handbook.

Concussion/suspected concussion

If a competitor is involved in an incident which results in him being diagnosed by the Medical Officer/Paramedic as suffering from concussion or suspected concussion, the rider is not permitted to participate any further in that event.

Organisers are to notify ACU Head Office as soon as possible of any concussion or suspected concussion injuries and then will subsequently:

- a) Place the rider on the ACU Stop List
- b) Inform Organisers of forthcoming events that the Rider has suffered a concussion or suspected concussion injury and is therefore placed on the ACU Stop List
- c) Inform the Rider that he needs to see a Doctor and obtain a letter/doctor's certificate which confirms he is fit to resume competitive racing/participate in a practice/test session.

The recovery time for anyone diagnosed with concussion or suspected concussion is as follows:

- a) Over 20 years: Excluded immediately and suspended for a period of nine days.
- b) 16–19 years: Excluded immediately and suspended for a period of twelve days.
- c) 15 and under: Excluded immediately and suspended for a period of twenty three days.

The rider is not permitted to ride during the obligatory suspended periods outlined above and then only once he is in possession of a doctor's certificate/letter after the suspended period has expired.

If a competitor has been injured on a Saturday and is suffering from concussion or suspected concussion, and the Organiser is aware that the rider was intending to ride or is scheduled to ride somewhere else the next day, the Organiser will inform the Organiser of the event being held the next day so they are aware of the rider's injuries and as such he is prevented from participating in that event.

TSR32 LIABILITY FOR DAMAGE

A rider is liable for any damage caused by themselves, their passenger, or any agent, representative or servant acting on their behalf, during the meeting. The promoters may act as agents for such persons to agree and pay for any such damage, and the rider shall on demand reimburse the promoters any sum so paid.

TSR33 DISCLAIMER

It is condition of acceptance of entry that the promoters shall not be responsible for any damage to, or loss of a motorcycle or its accessories whether by fire, accident or any agent, representative or servant acting on their behalf, during the meeting.

TSR34 OFFENSIVE BEHAVIOUR

Any rider, or party with an interest in a rider's performance, reported to the Clerk of the Course for arguing or being offensive to an Observer, or other Official, renders that rider liable to disciplinary action. Where the Organiser supplies the Observer with a Yellow Card, the Observer may issue it to any rider who continues to hassle or abuse the Observer following a warning. Any rider who is issued a Yellow card will be reported to the Clerk of the Course who may issue further disciplinary action. The Organiser must report to the T&E Committee all incidents where disciplinary action has been taken for Offensive Behaviour.

TSR35 YOUTH AWARDS

Cash awards and gift vouchers are not permitted for Youth classes.

TSR36 JOINT ADULT/YOUTH EVENTS

Subject to the agreement of the Permit issuing Authority a Youth Class/Classes may be included in Adult events. Youths to ride the route as decided by the Clerk of the Course. A Youth must ride a machine of a maximum capacity/power and wheel size as appropriate to their age. Adults and Youths must compete for separate awards.

TSR37 COMPLIANCE WITH REGULATIONS

Every rider, by entering or being nominated, thereby acknowledges that he is bound by the National Sporting Code of the ACU and these Standing Regulations together with any Supplementary Regulations and Final Instructions to be hereafter issued, to all of which he undertakes to submit and moreover renounces any right to have recourse to any arbitration or tribunal not provided for in the said Rules and Regulations.

TSR38 RESULTS

For each event a set of Results must be produced which display the event date and Permit number. The method to be used for the publication of the results must be shown in the Supplementary Regulations or the Championship Regulations.

Acceptable formats are by post, email or website but in addition for every event a set of provisional results must be sent, either by post or by email, to the Permit issuing authority. These must clearly show the date and time of publication. If these provisional results are amended then a copy of the revised set, clearly marked "Amended (date)" must be sent by post or email to the Permit Issuing authority and any rider affected by the amendment.

TSR 39 PROTESTS

See Appendix B of this Handbook.

Where it has been previously stated in the Championship Regulations or Supplementary Regulations that the results will be announced at the conclusion of the event and the full results, signed by the Clerk of the Course (or appointed official) with the time of day, are displayed within 30 minutes of the last rider finishing, any protest must be submitted within 30 minutes of the time of signing.

Where the above for any reason does not apply (e.g results are announced later, sent by post, email or published on a website) any protest must be submitted within 5 days of publication.

The date of publication of results must be shown on the results displayed on a website or sent by email, or confirmed by postmark if mailed and the Protest period will commence from this date.

Protest against the Capacity/power of a motorcycle must be accompanied by a deposit of £250 to cover associated costs.

TSR40 POWER WASHERS

It is prohibited to use power washers, unless the organisers offer suitable facilities which comply with the ACU Environmental Code.

TSR41 FIRE EXTINGUISHERS

There shall be at least one fire extinguisher at the start of each event and at any subsequent designated refuelling areas. (Mobile phones must not be used in designated refuelling areas).

TSR42 INTERPRETATION

The interpretation of these Standing Regulations and the Supplementary Regulations or Instructions to rider will rest entirely with the Stewards of the Meeting whose decision shall be final and binding except as provided in the National Sporting Code.

TRIALS – MACHINE EXAMINER'S CHECK LIST**GENERAL TRIALS**

Machines should be in general good condition with no obvious parts missing or not working. Should be adequately silenced and the following checked:

- Brake and Clutch levers should have in principle ball ended levers
- Folding Footrests
- Self closing throttle

- Have trials tyres
- Have a helmet and suitable boots

For **youth competitors** the additional items should be checked:

- Operation of cut out device
- Correct engine and wheel size size for age of rider
- Have gloves and the forearms covered

And **sidecars** should have:

- Operation of cut out device
- A nose cone
- Seat for the passenger
- Passenger has helmet and suitable boots

For entries in ACU Championships please refer to current Championship Regulations.

TRIALS OFFICIALS

QUALIFICATIONS AND CONDITIONS

Officials are divided into two categories: Those that are Licensed and those that are Registered. No Fees are payable in respect of any Licences or Registration or for the appropriate form of identification issued.

LICENCES: Senior Officials are required to hold an ACU Licence of the appropriate Grade for the performance of their duties.

	See Note Below	Licence Required	Attendance at Seminar/ Training Session
Clerk of the Course	1	YES	Renew licences every third year
Chief Steward	2	YES	Renew licences every third year
Club Stewards		No	May attend Regional or ACU HQ Seminars

Clubs and Centres shall only nominate candidates whose aptitude and integrity for the position they can fully justify. Official ACU approval and the issue of a Licence is only after the candidates have proved to be competent according to the special requirements for each discipline. The respective Committees and Panels organise Seminars that are compulsory for certain Officials. A Licence is valid for 3 years.

Note 1 Clerk of the Course

GRADES

Regional must attend a seminar organised by a Centre/Region.

National must attend a National seminar organised by the Trials & Enduro Committee and must also comply with specific criteria.

Note 2 Steward

GRADES

Regional will be appointed by the Centre as the Permit issuing authority as required.

National will be appointed by the Trials & Enduro Committee as the Permit issuing authority and must also comply with specific criteria.

LICENCE FEES All licences will be issued, free of charge, for a period of three years.

Arena Trials

The National Sporting Code of the ACU and these Standing Regulations shall apply to all Arena Trials together with the Supplementary Regulations and any Final instructions issued for individual events.

1 GENERAL

- 1.1 **Description.** An Arena Trial is a test of riding skill and balance over a variety of observed obstacles with riders incurring penalties for footing or for failing to fulfil other conditions. The obstacles (Sections) are usually man made, specifically for the event which is held within an arena or stadium. The Standing Regulations for Trials (TSRs) as printed in this Handbook shall be applicable with the following amendments.
- TSR3** Entries shall be by the invitation of the organising Club.
- TSR20** The order in which the Sections shall be attempted must be explained to the riders at the briefing meeting.
- TSR21** Any obstacle which is more than 1000mm from the ground and has a width of less than 500mm shall have a firm support below and along the full length of the said obstacle. The "Start" and "End" of each Section shall be clearly marked and the lateral limits clearly explained at the briefing meeting.
- TSR22** The method of marking shall be to TSR22A.
- TSR28** Prior to the start of the above event the Clerk of the Course must hold a briefing meeting which must be attended by all riders, the Referee and the Observer(s). The Clerk of the Course must inform the riders of the lateral limits of each Section, the order that they will be attempted in and any other information for the smooth running of the event.
- TSR33** A person holding a certificate of First Aid competency must be present throughout the duration of the event. The organiser shall be conversant with the nearest Accident/Emergency services and have the means of contacting them.
- TSR41** It is not permitted to hold an Arena Trials on a Time and Observation basis.

Additionally the following apply:

1. **Referee.** A Referee shall be appointed by the body issuing the permit who must carry out a course inspection prior to the start. The Referee shall replace the Stewards of the Meeting and have the same powers and obligations.

Duties of the Referee

 - a) He shall be in attendance throughout the meeting and for such further period of time as be necessary for him to complete his duties arising therefrom.
 - b) He shall have the duty of enforcing these Regulations.
 - c) He shall prohibit from competing a rider whom, or a motorcycle which, he considers might be a source of danger.
 - d) He shall immediately deal with any appeal that may properly be delivered to him during a meeting.
2. **Permit.** A permit may be issued by a Local Centre for events of up to Centre Restricted, which must comply with the following restrictions:
 - a) The event is not televised other than for local promotional reasons where the transmission must not exceed 5 minutes.
 - b) No Audience participation.
 - c) No involvement of "Fire" in the display,
 - d) No free-style jumping or jumping competition.
 - e) Only controlled riding over obstacles NOT jumping over vehicles or people.
 - f) Estimated audience not to exceed 1,000.

- g) Any “Contractual Terms” must exclude any liability upon the organiser for slipping or tripping in public areas or in Grandstands or in Car Parks.
In all other cases the Permit must be issued by the ACU Office.
3. **Spectator safety.** Where no wooden paling or interlinked metal public fence is provided double roping must be erected. The inner rope must be a minimum of 7m from the obstacles and the outer rope must be a distance of 4m from the inner rope.

ACU Normandale Masters Trials Championship

These Championship Regulations to apply in addition to the National Sporting Code, Standing Regulations for Trials and the Supplementary Regulations for each event.

Championship points will be awarded to competitors of any Nationality. The title “ACU Normandale Masters Trials Champion” will be awarded to the competitor with the most points who holds British Citizenship. If a competitor with the most points is not a British Citizen they will be awarded the title “ACU Open Normandale Masters Trials Champion”. This principle will apply throughout the Championship classes.

- 1 **Title of Event.** All Supplementary Regulations and Programmes must include the words “A round of the ACU Normandale Masters Trials Series” in the heading and reference to the sponsor, if any, is to be made at the beginning of the regulations.
- 2 **Series Sponsor.** Where there is a Series Sponsor who provides bibs/riding numbers, these must be used by the rider without alteration or the obscuring of Sponsors’ logo
- 3 **Qualifying Meetings.** The list of events may be found in the current ACU Fixture List.
- 4 **Eligibility.** Priority of entry at the closing date will be given to Championship points scorers from the current series and the previous year subject to completed entry forms being received by that date. Any entry once accepted by the organiser renders the rider eligible for awards and Championship points.

5 Championship Classes

CLASS 1	Over 40 (at the date of the competition)	ROUTE 1
CLASS 2	Over 50 (at the date of the competition)	ROUTE 2
CLASS 3	Over 60 (at the date of the competition)	ROUTE 2
CLASS 4	Air-cooled Monoshocks (no rider age restriction)	ROUTE 2
CLASS 5	Twinshock Class (Must have twin rear suspension units and drum brakes as at the time of manufacture)	ROUTE 2

NB: ROUTE 1 = Standard Route

ROUTE 2= Easier Route

Competitors can only enter ONE Class.

All riders in the same class must ride the same route.

Note Where Sidecars are included in the event it is strongly recommended that separate sections are provided.

The organisers may introduce an additional non Championship class for riders who are not eligible for the Championship classes on Route 1 or Route 2 Priority must be given to Championship entrants if the number of entries is limited.

- 6 **Course** The course shall be on or off road, which must be clearly stated in the Supplementary regulations and be, of no more than 2 laps with a total overall distance of between 5 and 30 miles.
To qualify as a finisher and be eligible for an award, with the exception of a section where the rider has recorded a failure, the rider’s machine must have travelled the whole distance under its own power or the exertion of the rider and passenger
- 7 **Observed Sections.** The sections shall be of natural terrain, i.e. no man made materials shall be used, and should be suitable for all classes.
- 8 **Marking.** Marking will be to TSR22 B No stop permitted.
- 9 **Starting Intervals.** All riders must start at one minute intervals.

All Championship class riders must start consecutively.

- 10 **Time.** If a time restraint is applied to part of or all of the Trial, it shall be in the form of an individual Time Allowance for each rider and the details given in the Supplementary Regulations or Final Instructions.
- 11 **Championship Points.** Championship points will be awarded to the top 15 eligible finishers in each class at each round on the following scale:

1st 20 points	6th 10 points	11th 5 points
2nd 17 points	7th 9 points	12th 4 points
3rd 15 points	8th 8 points	13th 3 points
4th 13 points	9th 7 points	14th 2 points
5th 11 points	10th 6 points	15th 1 point

Should a Tie occur it is to be resolved in accordance with TSR23 A)
Riders who score points in one championship class shall not be eligible for points in another championship class
- 12 **Final Assessment.** At the conclusion of the Series, the points for each rider’s best results from all rounds held will be added together and the rider with the highest number of points to his credit will be awarded the relevant Championship title.
Should a tie occur it is to be resolved in accordance with TSR23 B)
- 13 **Protests.** Protests to be in accordance with TSR 39.
- 14 **Awards.** The organisers shall supply a minimum of one award to the first placed rider in each class in the event. The first three placings in each class will be presented with certificates at the conclusion of the series whilst the individual class winner will receive an award which will be presented, together with an ACU medal, at the annual ACU Awards Presentation.
- 15 **Jurisdiction.** IN GRANTING A PERMIT TO “PROMOTE” THE COMMITTEE DOES NOT ABROGATE ITS OVERALL RESPONSIBILITY FOR THE CHAMPIONSHIP SERIES AND MAY IN ITS ABSOLUTE DISCRETION, WITHHOLD POINTS FOR ALL OR PART OF A “ROUND” INTRODUCING A REPLACEMENT EVENT AT A LATER DATE IF SEEN FIT.

ACU Wessex Plant Hire British Sidecar Trials Championship

These Championship Regulations to apply in addition to the National Sporting Code, Standing Regulations for Trials and the Supplementary Regulations for each event.

Championship points will be awarded to competitors of any Nationality. The title “Wessex Plant Hire ACU British Sidecar Trials Champion” will be awarded to the competitor with the most points who holds British Citizenship. If the competitor with the most points is not a British Citizen, they will be awarded the title of “Wessex Plant Hire British Open Sidecar Trials Champion”. This principle will apply throughout the Championship classes.

- 1 **Title of Event.** All Supplementary Regulations and programmes must include the words “A round of the ACU Wessex Plant Hire British Sidecar Trials Championship”.
- 2 **Series Sponsor.** Where there is a Series Sponsor who provides bibs/riding numbers, these must be used by the rider without alteration or the obscuring of Sponsors’ logo
- 3 **Qualifying meetings.** The list of events will be found in the current ACU Fixture List.
- 4 **Classes.** Class A – British Championship. Class B – ACU Intermediate Championship. Class C – ACU Clubmans Championship. Class D – ACU Newcomer. (A newcomer is classified as a rider who has never competed in the British/ACU Trials Championship on any class of sidecar machine prior to the current year).
The Organiser may at their discretion add a Non Championship Sportsman’s class (Class E). The Intermediate Class will ride a 50/50 combination of Championship and Clubmans sections as determined and identified by the Clerk of the Course.
- 5 **Eligibility.** To be eligible for ACU Clubman Championship and ACU Intermediate Championship points, riders must not have won that Championship class in the previous year. Championship class riders may downgrade at the discretion of the Trials and Enduro Committee. Riders not eligible for points (as detailed above) may compete on a no points basis.
The named Driver and Passenger must complete the entire Trial in their respective positions to be eligible for points
- 6 **Entries** Any entry once accepted by the organiser renders the rider eligible for awards and Championship points
Acceptance or Refusal of Entry. The organiser should notify all riders of the position regarding their entry prior to the event.
- 7 **Starting Order.** The organiser shall determine the starting order within each class by ballot. Class C will start first, then Class D, then Class B, then Class A, then Class E. Riding numbers for the Championship class (Class A) will correspond to the rider’s finishing position in the previous year.
- 8 **Starting Intervals.** All riders must start at one minute intervals.
- 9 **Method of Marking.** The Championship will be held under TSR22B – Non Stop.
- 10 **Time.** If a time restraint is applied to all or part of a Trial, it shall be in the form of an individual Time Allowance for each rider and the details given in the Supplementary Regulations or Final Instructions.
- 11 **Championship Points.** Championship points for each class will be awarded to the top 15 eligible finishers in each round on the following scale:

1st 20 points	6th 10 points	11th 5 points
2nd 17 points	7th 9 points	12th 4 points
3rd 15 points	8th 8 points	13th 3 points

4th 13 points 9th 7 points 14th 2 points
 5th 11 points 10th 6 points 15th 1 point

Should a Tie occur it is to be resolved in accordance with TSR23 (a)

A rider who scores points in one Championship class shall not be eligible for points in another Championship class.

12 **Protests.** Protests in this Championship must be submitted within 30 minutes of the announcement of results provided the results are displayed within 30 minutes of the last rider finishing.

13 **Final Assessment.** At the conclusion of the Series, the points for each rider’s performance in all rounds held will be added together and the rider with the highest number of points to his credit will be awarded the relevant Championship title.

Should a tie occur it is to be resolved in accordance with TSR23 (b)

14 **Course.** The course shall be between 6 and 30 miles, with a minimum of 36 subsections. No more than 2 laps to achieve minimum mileage. In addition no more than 10 double sub sections must be used.

To qualify as a finisher and be eligible for an award, with the exception of a section where the rider has recorded a failure, the rider’s machine must have travelled the whole distance under its own power or the exertion of the rider and passenger.

15 **Observed Sections.** The sections should be of a natural terrain i.e. no man-made artificial hazards. Sections for the Intermediate Class will be determined by the Clerk of the Course and identified accordingly.

16 **Awards.** The Organisers shall supply a minimum of one award to the first placed rider in each class in the event. The first three placings in each class will be presented with certificates at the conclusion of the series whilst the individual class winners will receive an award which will be presented together with an ACU medal at the annual ACU Awards Presentation.

Where more than one passenger accompanies the driver in the series the passenger named on the award shall be the one who rides in the most rounds. Should a tie still remain then the award will go to the passenger who accompanies the rider at the last round.

17 **Jurisdiction.** IN GRANTING A PERMIT TO “PROMOTE” THE TRIALS AND ENDURO COMMITTEE DOES NOT ABROGATE ITS OVERALL RESPONSIBILITY FOR THE CHAMPIONSHIP SERIES AND MAY IN ITS ABSOLUTE DISCRETION, WITHHOLD POINTS FOR ALL OR PART OF A “ROUND” INTRODUCING A REPLACEMENT EVENT AT A LATER DATE IF SEEN FIT.

ACU Belle Trailers British Ladies and Girls Trials Championships

These Championship Regulations to apply in addition to the National Sporting Code, Standing Regulations for Trials and the Supplementary Regulations for each event.

Championship points will be awarded to competitors of any Nationality. The title “ACU Belle Trailers British Ladies and Girls Trials Championships” will be awarded to the competitor with the most points who holds British Citizenship. If the competitor with the most points is not a British Citizen they will be awarded the title “ACU Belle Trailers British Ladies/Girls Open Trials Champion”. This principle will apply throughout the Championship classes.

- 1 **Title of Event.** All Supplementary Regulations and Programmes must include the words – “incorporating the ACU Belle Trailers British Ladies And Girls Trials Championships”.
- 2 **Series Sponsor.** Where there is a Series Sponsor and the Organiser provides bibs/riding numbers, these must be used by the rider without alteration or the obscuring of sponsors’ logo.
- 3 **Eligibility.** All riders in the Championship classes must be of the female gender. Classes for girls are as defined under youth riders in TSR1.
- 4 **Classes**
 Ladies Championship
 Girls A Championship
 Ladies 50/50 Championship
 Ladies Intermediate Championship
 Girls A Intermediate Championship
 Girls B Championship
 Girls C Championship
 Girls D Championship
 Ladies Sportsperson (Non Championship)
 Girls Sportsperson (Non Championship)
- 5 **Starting.** Starting intervals shall be at intervals of 1 minute.
- 6 **Cut Out Device.** All competitors riding combustion engine machines must have cut out devices rigidly connected to the rider by lanyard (max length 1 metre) so as to stop the engine should the rider and machine be parted.
- 7 **Time Allowed.** There will be an overall individual time allowance for the Trial. The Final Time Control must be located immediately after the final section. The rider is obliged to go directly from the Final Control to the Results Recorder. Any rider who delays the publication of a result will be reported to the Stewards of the Meeting for disciplinary action.
- 8 **Method of Marking.** The Championship will be held under TSR 22B.
- 9 **Course.** The course will be entirely on private land and will consist of a minimum of ten Sections. NB The maximum lap length must be no more than 2 miles (measured accurately) taking into account accessibility for parents who will be on foot
 There will be 3* routes as follows:
 ROUTE 1 Ladies Championship Class
 50% ROUTE 1 and 50% ROUTE 2 Girls A Championship Class
 Ladies 50/50 Championship Class
 ROUTE 2 Ladies Intermediate Championship Class
 Girls A Intermediate Championship Class
 Girls B Championship Class
 ROUTE 3 Girls C Championship Class

Girls D Championship Class
 Ladies Sportsperson (Non Championship)
 Girls Sportsperson (Non Championship)

***Note:** In the Girls D Championship Class a 4th route may be offered at the discretion of the organisers if practical

All routes to be clearly distinguished with appropriate marking, particularly where routes are split.

To qualify as a finisher and be eligible for an award, with the exception of a section where the rider has recorded a failure, the rider's machine must have travelled the whole distance under its own power or the exertion of the rider and passenger.

10 **Assistants.** Each Rider may register one Assistant to accompany them on the course and carry tools. The Assistant must comply with the following:

- The Assistant must be a minimum age of 18 years
- The Assistant must pay a fee.
- The Assistant is NOT allowed to ride a motorcycle.
- The Assistant will only be allowed into the boundaries of a section if their rider is in that section and if specifically invited by an official.
- The Assistant must wear identification supplied by the organiser

The rider and the assistant must sign a declaration that the rider is responsible for all the actions of the assistant. In the case of an injury, a substitute assistant may be registered.

The rider's machine must travel the whole distance of the course under its own power or the exertion of the rider.

N.B. The Organiser must charge an Assistants fee to cover insurance etc and the Assistant must be issued with identification eg. Bib, Armband etc

11 **Championship Points.** Any entry once accepted by the organiser renders the rider eligible for awards and Championship points. Championship points will be awarded to the top 15 eligible riders in each Championship Class at each event on the following scale for each class:

1st 20 points	6th 10 points	11th 5 points
2nd 17 points	7th 9 points	12th 4 points
3rd 15 points	8th 8 points	13th 3 points
4th 13 points	9th 7 points	14th 2 points
5th 11 points	10th 6 points	15th 1 point

Should a Tie occur it is to be resolved in accordance with TSR23 (a)

A rider who scores points in one Championship class shall not be eligible for points in another Championship class.

12 **Awards.** The organisers shall supply a minimum of one award to the first placed rider in each class. The first 3 placings in each Ladies class and the first 3 placings in each Girls class will be presented with certificates at the conclusion of the series. The individual Ladies class winners and the first 3 Girls class winners will receive an award which will be presented together with an ACU medal at the Annual ACU Awards Presentation.

13 **Protests.** Protests in this Championship must be submitted within 30 minutes of the announcement of results provided the results are displayed within 30 minutes of the last rider finishing.

14 **Final Assessment.** At the conclusion of the series, the points for each rider's performance from all rounds held will be added together and the rider with the highest number of points to her credit will be awarded the relevant Championship title.

Should a tie occur it is to be resolved in accordance with TSR23 (b)

15 **Jurisdiction.** IN GRANTING A PERMIT TO 'PROMOTE' THE COMMITTEE DOES NOT ABROGATE ITS OVERALL RESPONSIBILITY FOR THE CHAMPIONSHIP SERIES AND MAY IN ITS ABSOLUTE DISCRETION, WITHHOLD POINTS FOR ALL OR PART OF A 'ROUND' INTRODUCING A REPLACEMENT EVENT AT A LATER DATE IF SEEN FIT.

ACU S3 Parts National Trials Championship

These Championship Regulations to apply in addition to the National Sporting Code, Standing Regulations for Trials and the Supplementary Regulations for each event.

Championship points will be awarded to competitors of any Nationality. The title “ACU S3 Parts National Trials Champion” will be awarded to the competitor with the most points who holds British Citizenship. If the competitor with the most points is not a British Citizen, they will be awarded the title “ACU S3 Parts National Open Trials Champion”. This principle will apply throughout the Championship classes.

- 1 **Title of Event.** All Supplementary Regulations and Programmes must include the words – “incorporating the ACU S3 Parts National Trial Championship”. Where possible the sponsor’s logo provided must be used.
- 2 **Series Sponsor.** When the Series Sponsor provides bibs/riding numbers, these must be used by the rider without alteration or the obscuring of Sponsors’ logo
- 3 **Eligibility.** Any entry once accepted by the organiser renders the rider eligible for awards and Championship points. To be eligible for Championship points, (Classes A and B) the riders must not, in the previous three calendar years, have
 - Finished in the top ten places in the final standings of the British Solo Trials Championship in the previous three calendar years.
 - Won the British Solo Expert Class of the British Solo Trials Championship in the previous three calendar years.
 - Won the S3 Parts ACU National Trials Championship more than once in the previous three years.

Exceptions may be made at the discretion of the Trials and Enduro Committee.

PRIORITY OF ENTRY AT THE CLOSING DATE IS TO BE GIVEN TO RIDERS IN THE S3 PARTS CHAMPIONSHIP CLASSES

4 **Route 1** (hardest)

Class A – All riders eligible for S3 Parts Expert Championship points.

Class B – Riders eligible for S3 Parts Expert Championship points and riding a machine not exceeding 125cc are also eligible for points in the “125cc S3 Parts Championship.

Class C – Additional riders not eligible for Championship points (as described above) who wish to ride the Championship route through the sections. Organisers may include a 3rd route of up to 10 sections of higher severity for this class.

Route 2 (Easier)

Class D – All riders eligible for S3 Parts Clubman Championship points

Class E – Riders aged 40 and over at the date of the competition

5 **Sections.**

Riders riding Classes A, B and C will ride the principal route through all sections.

Riders riding Classes D and E will ride sections with easier variations to at least 50% of the sections

6 **Start Order.** Riders will start at one minute intervals

First round of the series: Riders will start in the following group order:

First – All riders in the Clubman Championship.

Second – All riders entered in the S3 Expert Class.

Third – All riders who finished in the top 15 of the S3 Expert Class in the previous year who are still eligible for points.

Fourth – All riders ineligible for points.

Riders will be balloted within their groups except for the top 15 group who will start in reverse order of the previous year's ranking.

For subsequent rounds riders will be grouped as follows:-

First – All riders in the Clubman Championship.

Second – All riders in the S3 Expert Class.

Third – Top 15 points scorers of the current series in reverse order of their current standing.

Fourth – All riders ineligible for points.

Where there are 2 rounds in consecutive days, or on the same weekend the ranking of the top 15 will be based on their positions before the first of the two rounds.

- 7 **Time.** If a time restraint is applied to part of or all of the Trial, it shall be in the form of an individual Time Allowance for each rider and the details given in the Supplementary Regulations or Final Instructions.

- 8 **Championship Points.** Championship points for each class will be awarded to the top 15 eligible finishers in each round on the following scale:

1st 20 points	6th 10 points	11th 5 points
2nd 17 points	7th 9 points	12th 4 points
3rd 15 points	8th 8 points	13th 3 points
4th 13 points	9th 7 points	14th 2 points
5th 11 points	10th 6 points	15th 1 point

Should a Tie occur it is to be resolved in accordance with TSR23 (a)

- 9 **Final Assessment.** At the conclusion of the Series, the points for each rider's best results from all rounds held will be added together and the rider with the highest number of points to his credit will be awarded the relevant Championship title.

Should a tie occur it is to be resolved in accordance with TSR23 (b)

- 10 **Awards.** The organisers shall supply a minimum of three awards to the first placed riders in each class plus an award for the best 125cc award winner. The first three placings in each class will be presented with certificates at the conclusion of the series whilst the individual class winners will receive an award which will be presented together with an ACU medal at the annual ACU Awards Presentation.

- 11 **Special Notes.** Entry Form/Programme. Provision must be made for the declaration of eligibility for this Championship on the entry form and the programme must indicate which riders are eligible to compete.

- 12 **Protests.** Protests in this Championship must be submitted within 30 minutes of the announcement of results provided the results are displayed within 30 minutes of the last rider finishing.

- 13 **Course.** Whilst this is a National Trial, the Championship course must be laid out to a standard suitable for average Clubman riders with less challenging variations for riders in class D as detailed above. The course shall be between 6 and 30 miles, with a minimum of 36 subsections. No more than 2 laps to achieve minimum mileage. In addition no more than 10 double sub sections must be used.

To qualify as a finisher and be eligible for an award, with the exception of a section where the rider has recorded a failure, the rider's machine must have travelled the whole distance under its own power or the exertion of the rider and passenger

- 14 **Method of Marking.** The Championship will be held under TSR22B.

- 15 **Jurisdiction.** IN GRANTING A PERMIT TO "PROMOTE" THE COMMITTEE DOES NOT ABROGATE ITS OVERALL RESPONSIBILITY FOR THE CHAMPIONSHIP SERIES AND MAY IN ITS ABSOLUTE DISCRETION, WITHHOLD POINTS FOR ALL OR PART OF A "ROUND" INTRODUCING A REPLACEMENT EVENT AT A LATER DATE IF SEEN FIT.

ACU Trail Bike Series incorporating the ACU Trail Bike Championship

These Championship Regulations to apply in addition to the National Sporting Code, Standing Regulations for Trials and the Supplementary Regulations for each event.

The ACU will promote a Trail Bike Series which is aimed at riders who want an enjoyable day on and off road on their road legal machine with Observed Sections suitable for such machines.

Championship points will be awarded to competitors of any Nationality. The title "ACU Trail Bike Champion" will be awarded to the competitor with the most points who holds British Citizenship. If the competitor with the most number of points is not a British Citizen they will be awarded the title "ACU Open Trail Bike Champion".

- 1 **Title of Event.** All Supplementary Regulations and programmes must include the words "A round of the ACU Trail Bike Championship" and the name of any official series sponsor.
- 2 **Qualifying Meetings.** The list of events may be found in the current ACU Fixture List.
- 3 **Eligibility.** Trail Bike Series Open to machines that are fully legal to use the Public Highway fitted with working lights, Trials Spec Tyres as per TSR8 for championship class. Non championship class must be road legal & tread pattern at discretion of the organisers and as supplementary regulations, and must be silenced to comply with TSR 14.
 - A) Trail Bike Championship. Open to machines that comply with the following in addition to the above:
 1. Wheelbase not less than 1350mm
 2. Minimum 5 litre fuel tank
 3. Minimum seat length 350mm
 Converted Trial Bikes will be excluded from this Class. The organiser, in conjunction with the Trials & Enduro Committee, reserves the right to place machines regarded as ineligible in the appropriate Class, and the rider will therefore not qualify for Championship points.
 - B) Hybrid Trail Class (championship Route eligible but not an official championship 2020). Machines with a minimum seat height of 700mm using trials bike type running gear with larger tank and seat units, Trials Spec Tyres as per TSR8 and must be silenced to comply with TSR 14.
- 4 **Course.** It is recommended that the course should be between 25 and 75 miles in length and include 25 to 40 sub-sections suited to the type of machine and rider entered. It is recommended that tight turns and steep drops be avoided. Organisers have the option to offer a dual route on a maximum of 8 sections – the harder route for the Championship Class and the easier route for all other classes – with the dual routes being clearly marked. A rider shall be given the opportunity to inspect a section before riding it. To qualify as a finisher and be eligible for an award, with the exception of a section where the rider has recorded a failure, the rider's machine must have travelled the whole distance under its own power or the exertion of the rider and passenger
- 5 **Method of Marking.** As per TSR22 B Non Stop.
- 6 **Championship Points.** Any entry once accepted by the organiser renders the rider eligible for awards and Championship points. Championship points will be awarded to the top 15 eligible finishers at each round on the following scale:

1st 20 points	6th 10 points	11th 5 points
2nd 17 points	7th 9 points	12th 4 points
3rd 15 points	8th 8 points	13th 3 points

4th 13 points	9th 7 points	14th 2 points
5th 11 points	10th 6 points	15th 1 point

Should a Tie occur it is to be resolved in accordance with TSR23 (a)

- 7 **Final Assessment.** At the conclusion of the Series, the points for each rider’s results from all rounds held will be added together and the rider with the highest number of points to his credit will be awarded the relevant Championship title.
Should a tie occur it is to be resolved in accordance with TSR23(b)
- 8 **Protests.** In this Championship must be submitted within 30 minutes of the announcement of results provided the results are displayed within 30 minutes of the last rider finishing.
- 9 **Awards.** The organisers shall supply a minimum of one award to the first placed rider in each class. The first three placings in each class will be presented with certificates at the conclusion of the series whilst the individual class winners will receive an award, which will be presented, together with an ACU medal, at the annual ACU Awards Presentation.
- 10 **Jurisdiction.** IN GRANTING A PERMIT TO “PROMOTE” THE COMMITTEE DOES NOT ABROGATE ITS OVERALL RESPONSIBILITY FOR THE CHAMPIONSHIP SERIES AND MAY, AT ITS ABSOLUTE DISCRETION, WITHHOLD POINTS FOR ALL OR PART OF A “ROUND” INTRODUCING A REPLACEMENT EVENT AT A LATER DATE IF SEEN FIT

ACU Belle Trailers British Solo Youth Trials Championship

These Championship Regulations to apply in addition to the National Sporting Code, Standing Regulations for Trials and the Supplementary Regulations for each event.

Championship points will be awarded to competitors of any Nationality. The title “ACU Belle Trailers British Solo Youth Trials Champion” will be awarded to the competitor with the most points who holds British Citizenship. If the competitor with the most points is not a British Citizen they will be awarded the title “ACU Belle Trailers British Open Solo Youth Trials Champion”. This principle will apply throughout the Championship classes.

- 1 **Title of Event** All Supplementary Regulations and Programmes must include the words “A Round of The ACU Belle Trailers British Solo Youth Trials Championship”
- 2 **Series Sponsor.** Where there is a Series Sponsor who provides bibs/riding numbers, these must be used by the rider without alteration or the obscuring of Sponsors’ logo.
- 3 **Eligibility.** Open to A, B, C & D Class youth riders as defined under TSRI.
- 4 **Classes.** See TSR 1.
 A Class
 B Class
 C Class Std wheel
 C Class Med wheel (Combustion Engine & Electric)
 D Class Med wheel (Combustion Engine & Electric)
 D Class Small wheel (Combustion Engine & Electric)
- 5 **Routes**
 A Class will ride Route 1
 B Class will ride Route 2
 C Class Standard wheel will ride Route 3
 C Class Medium wheel Petrol & Electric combined will ride 50% Route 3 50% Route 4
 (NB where routes are split they must be clearly defined)
 D Class Medium wheel Petrol & Electric combined will ride Route 4
 D Class Small wheel will ride Route 5
 Any rider wishing to ride in a class lower than their age may do so on a no points basis
- 6 **Starting Order.** The riders will have their starting order determined by ballot.
- 7 **Starting Intervals.** All riders will start at one minute intervals, by class
- 8 **Cut Out Device.** All competitors’ machines must have cut out devices rigidly connected to the rider by lanyard (max length 1 metre) so as to stop the engine should the rider and machine be parted.
- 9 **Time Allowed.** There will be an overall individual time allowance for the Trial. The Final Time Control must be located immediately after the final section. The rider is obliged to go directly from the Final Control to the Results Recorder. Any rider who delays the publication of a result will be reported to the Stewards of the Meeting for disciplinary action.
- 10 **Assistants.** Each Rider may register one Assistant to accompany them on the course and carry tools. The Assistant must comply with the following:
 - The Assistant must be a minimum age of 18 years
 - The Assistant must pay a fee.
 - The Assistant is NOT allowed to ride a motorcycle.
 - The Assistant will only be allowed into the boundaries of a section if their rider is in that section and if specifically invited by an official.

- The Assistant must wear identification supplied by the organiser
- The rider and the assistant must sign a declaration that the rider is responsible for all the actions of the assistant. In the case of an injury, a substitute assistant may be registered. The rider's machine must travel the whole distance of the course under its own power or the exertion of the rider.

N.B. The Organiser must charge an Assistants fee to cover insurance etc and the Assistant must be issued with identification eg. Bib, Armband etc.

- 11 **Championship Points** Any entry once accepted by the organiser renders the rider eligible for awards and Championship points. Championship points will be awarded to the top 15 eligible finishers in each class at each round on the following scale: A rider can only gain Championship points from one class in one year.

1st 20 points	6th 10 points	11th 5 points
2nd 17 points	7th 9 points	12th 4 points
3rd 15 points	8th 8 points	13th 3 points
4th 13 points	9th 7 points	14th 2 points
5th 11 points	10th 6 points	15th 1 point

Should a Tie occur it is to be resolved in accordance with TSR23 (a)

Riders who score points in one championship class shall not be eligible for points in another championship class.

- 12 **Awards.** The organisers shall supply a minimum of one award to the first three placed riders in each class. Each class will be presented with certificates at the conclusion of the series and an award which will be presented, together with an ACU medal, at the annual ACU Awards Presentation.

- 13 **Protests.** Protests in this Championship must be submitted within 30 minutes of the announcement of results, provided the results are displayed within 30 minutes of the last rider finishing.

- 14 **Final Assessment.** At the conclusion of the series, the points for each rider's performance from all rounds held will be added together and the rider with the highest number of points to his credit will be the winner.

Should a tie occur it is to be resolved in accordance with TSR23 (b)

- 15 **Observed Sections.** Each observed section or subsection must be attempted in the order in which they are numbered, except where a class is instructed to start other than at Section 1, they must still attempt the sections consecutively. The sections should be of natural terrain, i.e. no man-made hazards and consecutively numbered.

- 16 **Method of Marking.** As per TSR 22B.

- 17 **Assistance on the Course** The rider may receive assistance to repair their machine anywhere on the course. The rider's machine must travel the whole distance of the course under its own power or the exertion of the rider.

- 18 **Course.** The number of laps and approximate length of lap must be stated in the Supplementary Regulations. NB The maximum lap length must be no more than 2 miles (measured accurately) taking into account accessibility for parents who will be on foot. To qualify as a finisher and be eligible for an award, with the exception of a section where the rider has recorded a failure, the rider's machine must have travelled the whole distance under its own power or the exertion of the rider and passenger

- 19 **Riding Bibs.** If bibs are supplied they must be worn by competitors throughout the event without any defacement.

- 20 **Jurisdiction.** IN GRANTING A PERMIT TO 'PROMOTE' THE COMMITTEE DOES NOT ABROGATE ITS OVERALL RESPONSIBILITY FOR THE CHAMPIONSHIP SERIES AND MAY IN ITS ABSOLUTE DISCRETION, WITH-HOLD POINTS FOR ALL OR PART OF A 'ROUND' INTRODUCING A REPLACEMENT EVENT AT A LATER DATE IF SEEN FIT.

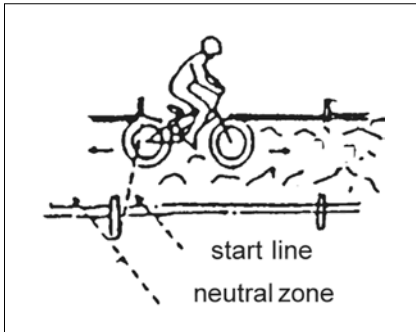

Fig 1

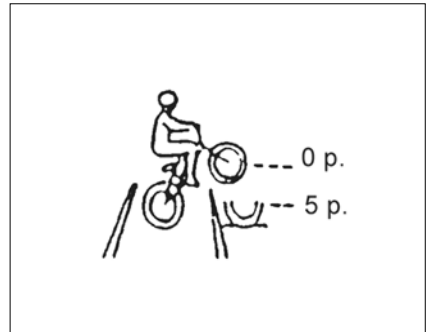

Fig 2

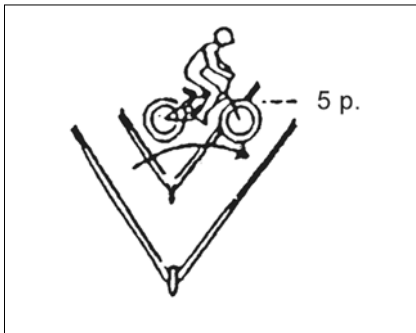

Fig 3

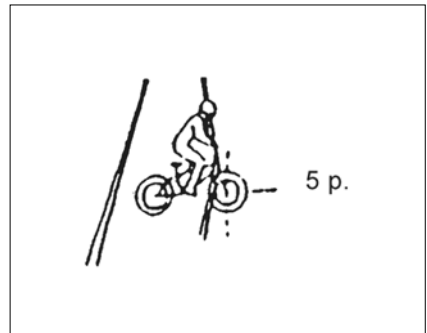

Fig 4

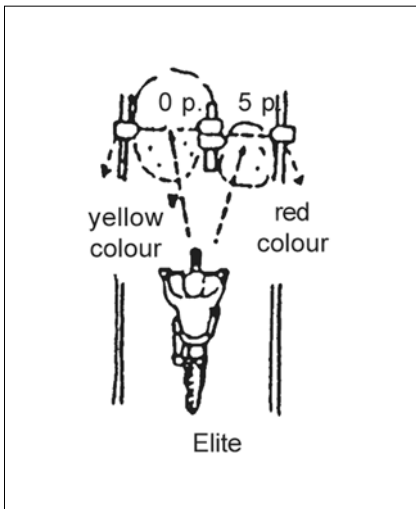

Fig 5

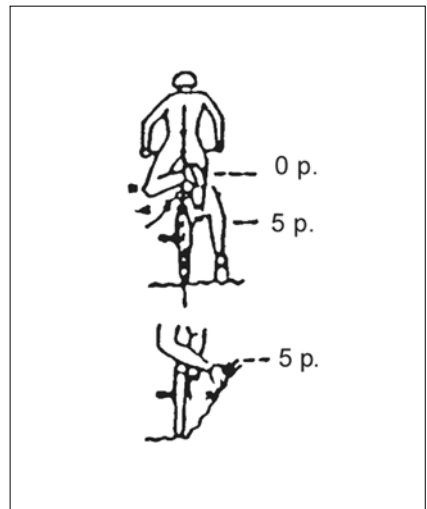

Fig 6